

2025/2026



ELETROFRIO
REFRIGERAÇÃO

Expositores refrigerados

Refrigerated Display Cases

Exhibidores refrigerados

vittrine

SOLUÇÕES COMPLETAS PARA SEU NEGÓCIO.

- Soluções técnicas e comerciais adequadas para cada loja;
- Soluções de alta eficiência e baixíssima carga de gás;
- Soluções remotas e com máquina acoplada;
- Soluções com fluidos naturais;
- Assistência técnica preventiva;
- Monitoramento remoto.

Não importa o tamanho da sua operação, a Eletrofrío tem a solução adequada e completa para o seu negócio.

COMPLETE SOLUTIONS FOR YOUR STORE.

- Technical and commercial solutions tailored for each store;
- High-efficiency solutions with minimal refrigerant charge;
- Remote solutions with integrated units;
- Solutions with natural refrigerants;
- Preventive technical support;
- Remote monitoring.

Regardless of the size of your operation, Eletrofrío has the right and complete solution for your business.

SOLUCIONES COMPLETAS PARA SU NEGOCIO.

- Soluciones técnicas y comerciales adecuadas para cada tienda;
- Soluciones de alta eficiencia y baja carga de fluido refrigerante;
- Soluciones remotas y con autocontenidos;
- Soluciones con fluido naturales;
- Asistencia técnica preventiva;
- Monitoreo remoto.

No importa el tamaño de su operación, Eletrofrío tiene la solución adecuada y completa para su negocio.



ÍNDICE

INDEX / ÍNDICE



Laticínios / Dairy / Lácteos - 04



Açougue / Meat / Carnes - 05



Confeitaria e Rotisseria / Bakery and Rotisserie / Confitería y Rotisería - 06



Fiambreteria / Deli / Fiambrería - 07



Hortifrúti / Produce / Horti - 08



Congelados / Frozen Food / Congelados - 09



Peixaria / Seafood / Pescados - 10



Atacado / Wholesale / Mayorista - 11



Bebidas / Beverages / Bebidas - 12



Soluções Frigoríficas, Termoisolantes e Armazenamento - 13
Refrigeration Solutions for the Cold Storage Warehouse Industry
Soluciones Frigoríficas, Termoaislantes y Almacenaje



Casas de Máquinas / Engine Room / Sala de Máquinas - 14



Cortes técnicos / Tabela de especificações técnicas - 15 a 21
Technical Drawings / Technical Specifications Table
Perfiles Técnicos / Tabla de especificaciones técnicas



Alguns acessórios são opcionais, consulte o representante.
Some accessories are optional, please consult the representative.
Algunos accesorios son opcionales, consulte el representante.

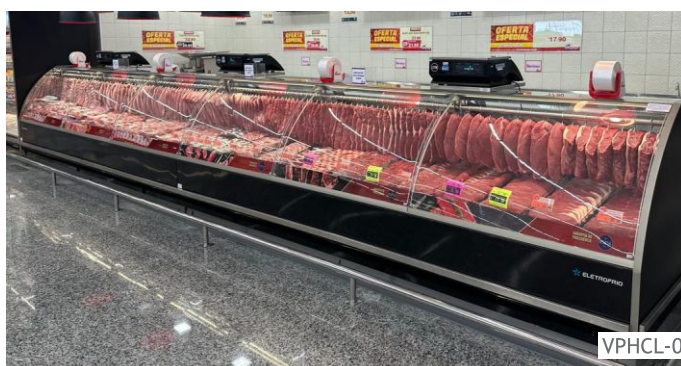
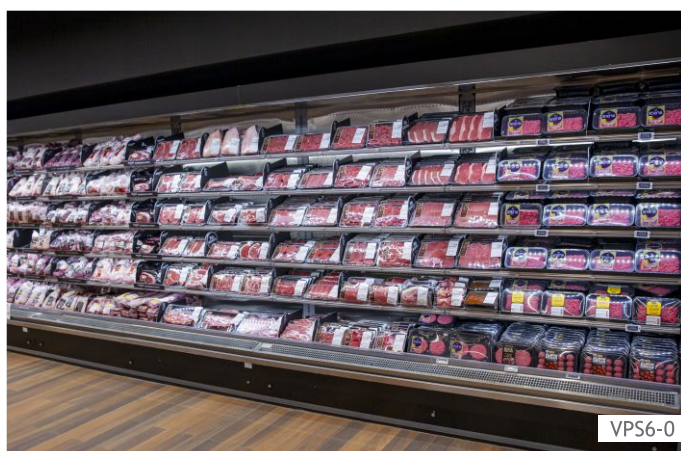

Alguns acessórios são opcionais, consulte o representante.

Some accessories are optional, please consult the representative.

Algunos accesorios son opcionales, consulte el representante.

Bakery and Rotisserie / Confitería y Rotisería

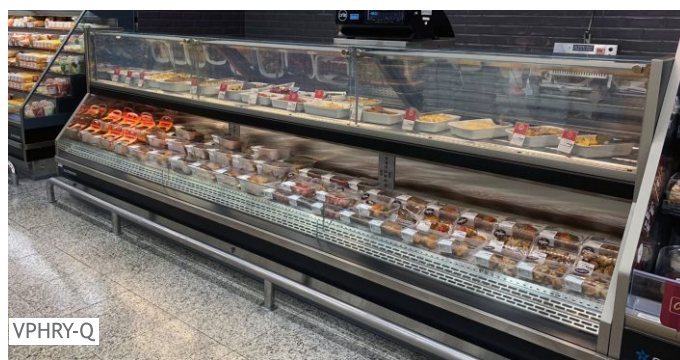
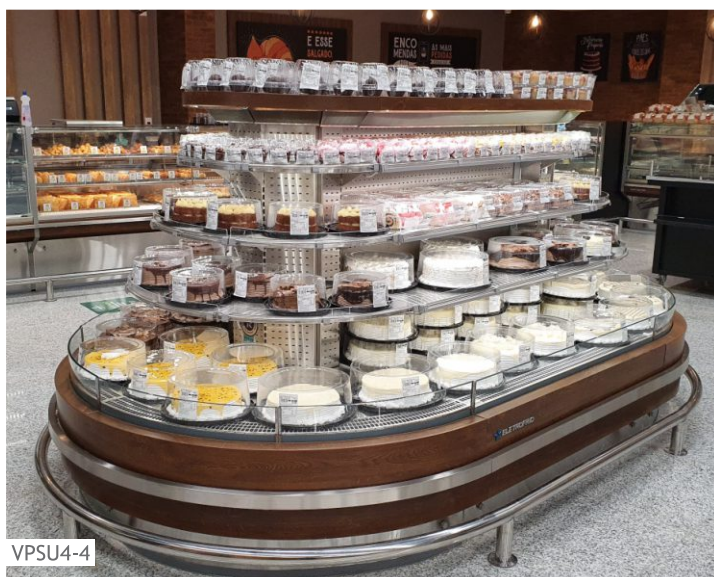

Alguns acessórios são opcionais, consulte o representante.

Some accessories are optional, please consult the representative.

Algunos accesorios son opcionales, consulte el representante.



Alguns acessórios são opcionais, consulte o representante.

Some accessories are optional, please consult the representative.

Algunos accesorios son opcionales, consulte el representante.



VPSB4-6



Expositor refrigerado para hortifrúti

VPFLV

Refrigerated display for produce
Exhibidor enfriado para hortifruti

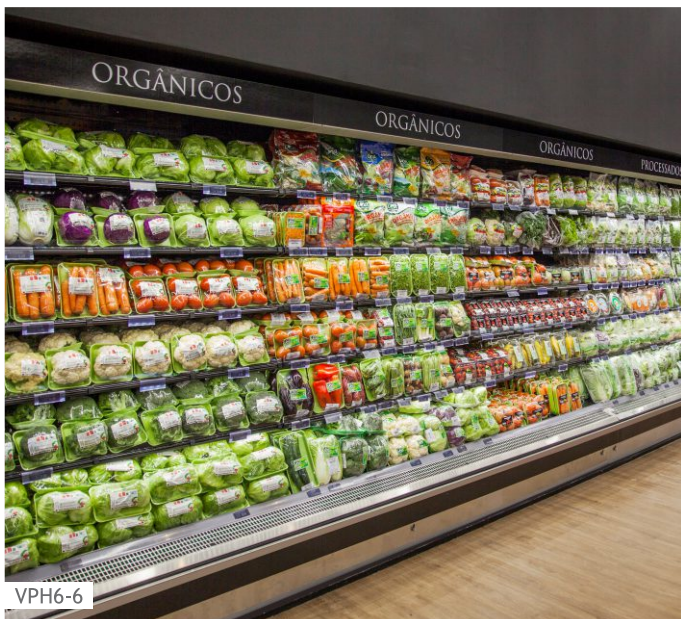

VPH6-6



Patente Requerida
EXTRA VISION

EVS6-6



VPHFL-6i



VPSU4-6

Alguns acessórios são opcionais, consulte o representante.

Some accessories are optional, please consult the representative.

Algunos accesorios son opcionales, consulte el representante.

Frozen Food / Congelados



VPHIC-18



VPSK-18



VPCIC-18



VPHY-18



VPHID-18



VPHK-18



VPSKY-18

Alguns acessórios são opcionais, consulte o representante.

Some accessories are optional, please consult the representative.

Algunos accesorios son opcionales, consulte el representante.



VPHRL-F e VPHERL-0



VPSB4-0



VPHRY-F



VPHF-F



VPS6-0



VPSKY-18

Alguns acessórios são opcionais, consulte o representante.

Some accessories are optional, please consult the representative.

Algunos accesorios son opcionales, consulte el representante.

Wholesale / Mayorista

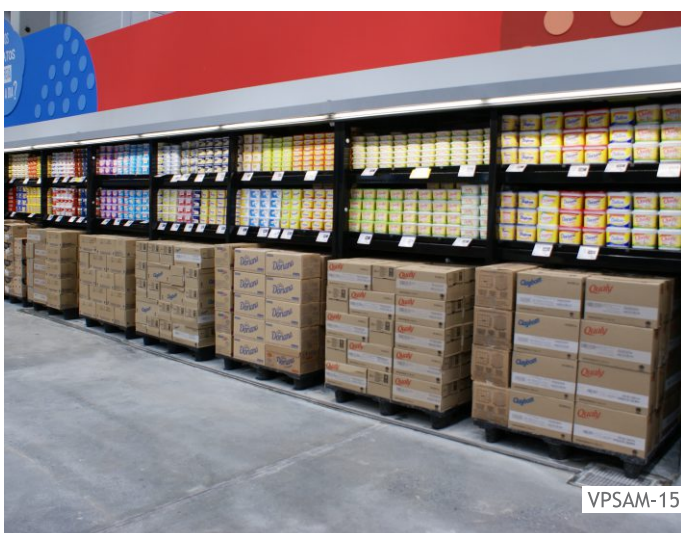
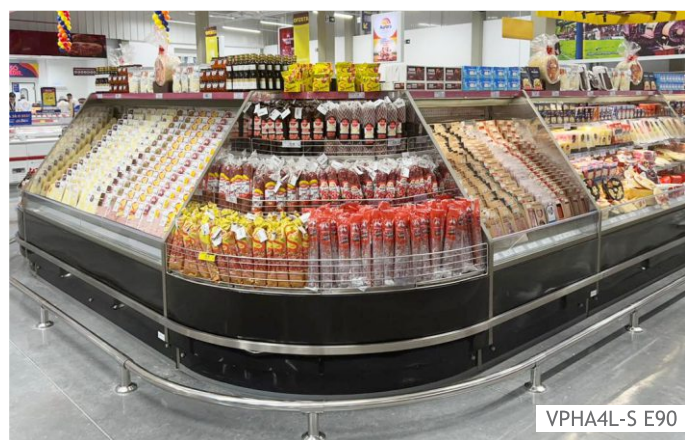
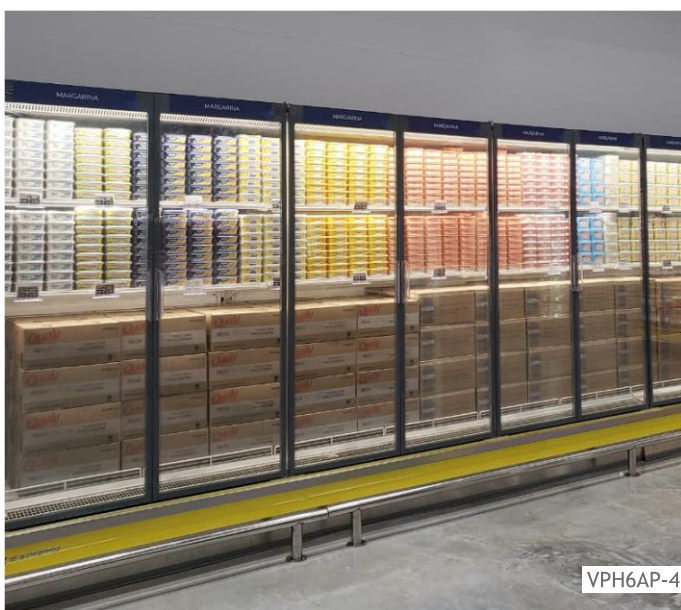

Alguns acessórios são opcionais, consulte o representante.

Some accessories are optional, please consult the representative.

Algunos accesorios son opcionales, consulte el representante.

Beverages / Bebidas



Patente Requerida
EXTRA VISION

EVS6-0



BEER CAVE



VPS6P-0



EVS6-0

Patente Requerida
EXTRA VISION



WALK IN COOLER

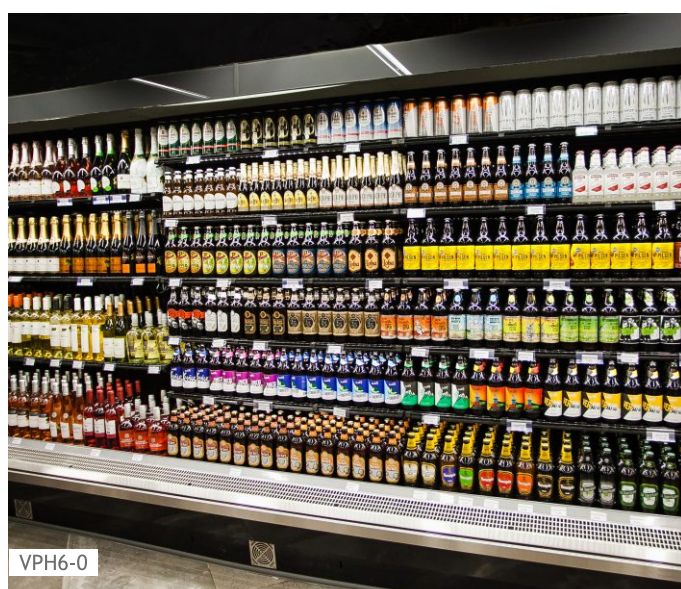

VPH6-0

Alguns acessórios são opcionais, consulte o representante.

Some accessories are optional, please consult the representative.

Algunos accesorios son opcionales, consulte el representante.

Refrigeration Solutions for the Cold Storage Warehouse Industry.
Soluciones Frigoríficas, Termoaislantes y em Almacenaje.



Alguns acessórios são opcionais, consulte o representante.

Some accessories are optional, please consult the representative.

Algunos accesorios son opcionales, consulte el representante.

Casas de Máquinas

Engine Room / Sala de Máquinas



<p>VPSCCL</p>	<p>VPSRL</p>	<p>VPSCB</p>
<p>VPSRB</p>	<p>VPHCL</p>	<p>VPHRL</p>
<p>VPHRLP</p>	<p>VPXRT</p>	<p>VPXRP</p>
<p>VPXRM</p>	<p>VPXRD</p>	<p>VPXRF</p>

Alguns acessórios são opcionais, consulte o representante.

Some accessories are optional, please consult the representative.

Algunos accesorios son opcionales, consulte el representante.

LANÇAMENTOS - LAUNCH - LANZAMIENTOS

VPFLV

Expositor refrigerado para hortifrúti

Refrigerated Display for Produce

Exhibidor enfriado para hortifruti

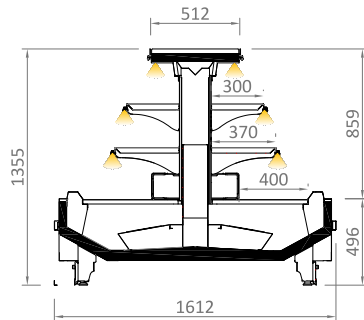

VM-Q

Expositor com mesa aquecida

Hot Table Display

Exhibidor con mesa caliente

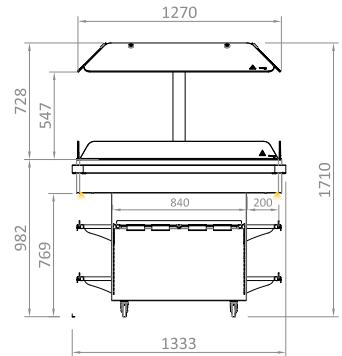

VPSECL

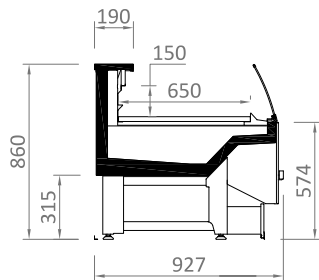

VPSERL

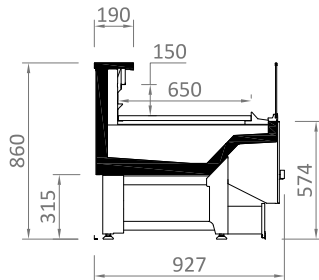

VPHECL

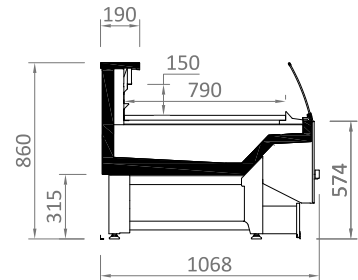

VPHERL

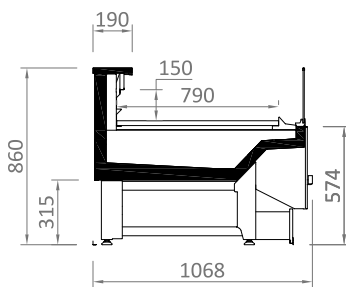

VPHERCL

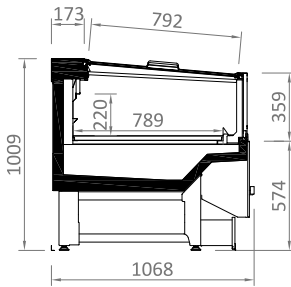

VPSPA3L

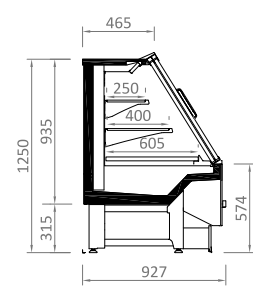

VPSPA3L

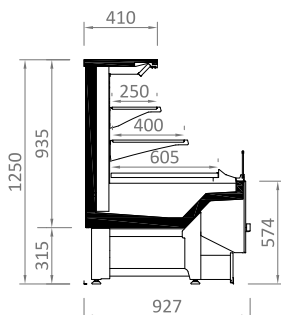

VPSPA3L

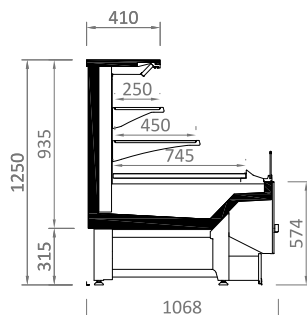

VPSPA3LP

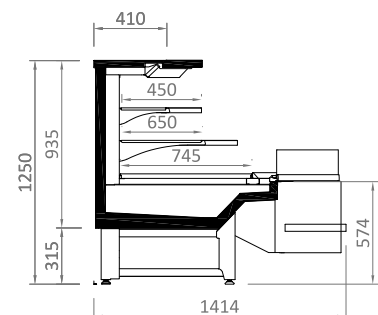

Alguns acessórios são opcionais, consulte o representante.

Some accessories are optional, please consult the representative.

Algunos accesorios son opcionales, consulte el representante.

<p>VPSPB3</p>	<p>VPSB3</p>	<p>VPHB3</p>
<p>VPSPB4</p>	<p>VPSB4</p>	<p>VPHB4</p>
<p>VPSPA4L</p>	<p>VPSA4L</p>	<p>VPHA4L</p>
<p>VPHA4LP</p>	<p>VPSU3</p>	<p>VPHU3</p>

Alguns acessórios são opcionais, consulte o representante.

Some accessories are optional, please consult the representative.

Algunos accesorios son opcionales, consulte el representante.

Technical drawings - Self-service / Perfiles técnicos - autoservicio

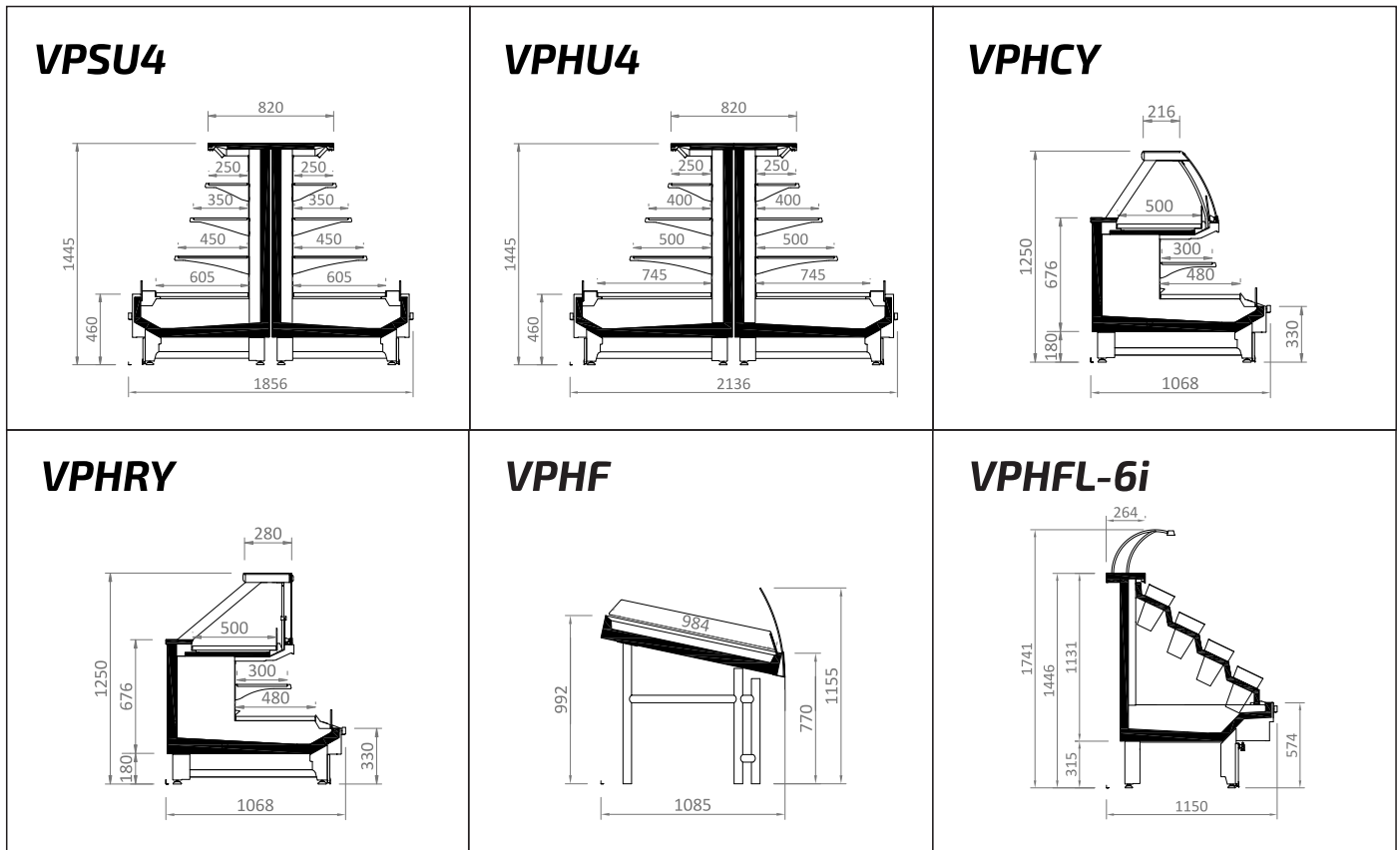

Cortes técnicos - verticais

Technical drawings - vertical / Perfiles técnicos - murales

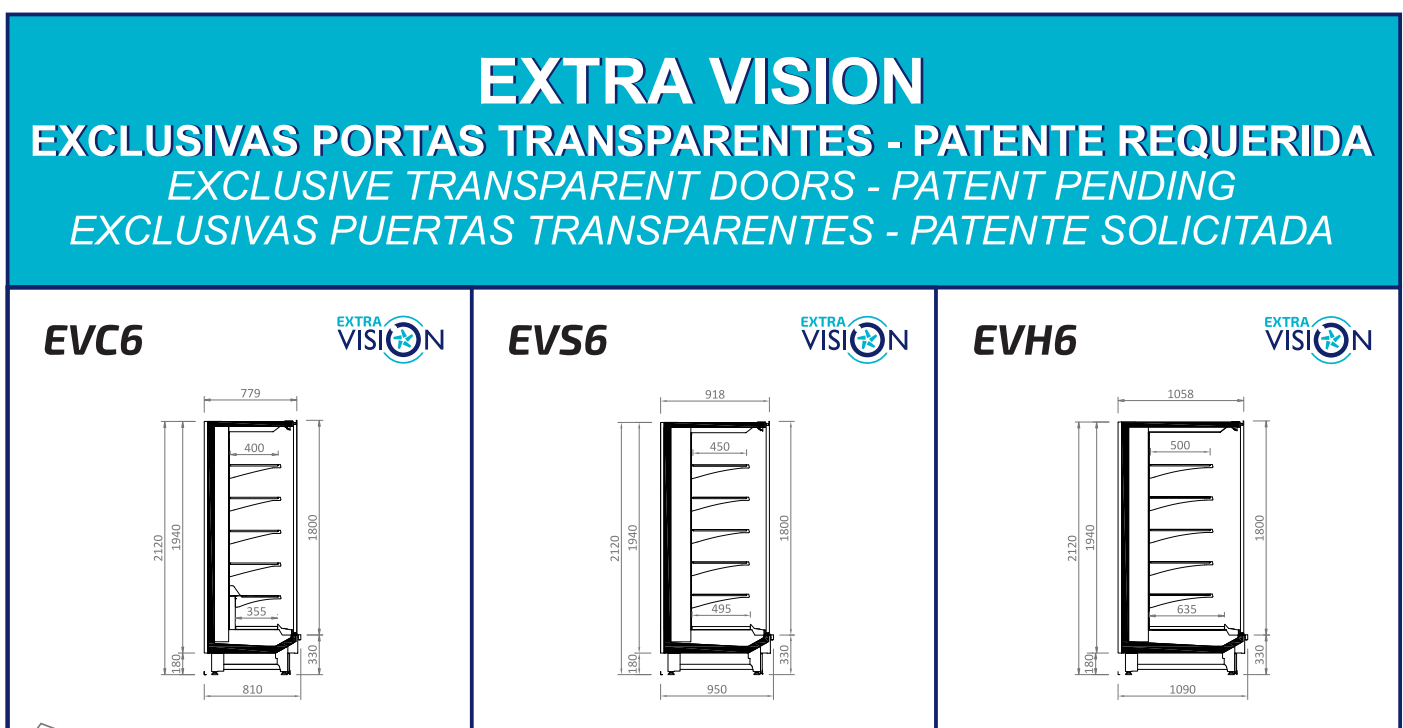

Alguns acessórios são opcionais, consulte o representante.

Some accessories are optional, please consult the representative.

Algunos accesorios son opcionales, consulte el representante.

<p>VPC6</p>	<p>VPC6P</p>	<p>VPS6</p>	<p>VPS6P</p>
<p>VPH6</p>	<p>VPH6P</p>	<p>VPH6A</p>	<p>VPH6AP</p>
<p>VPSAM</p>	<p>VPHAM</p>		

Cortes técnicos - congelados

Technical drawings - frozen / Perfiles técnicos - congelados

<p>VPCIYC</p>	<p>VPCIY</p>	<p>VPCIC</p>
----------------------	---------------------	---------------------

Alguns acessórios são opcionais, consulte o representante.

Some accessories are optional, please consult the representative.

Algunos accesorios son opcionales, consulte el representante.

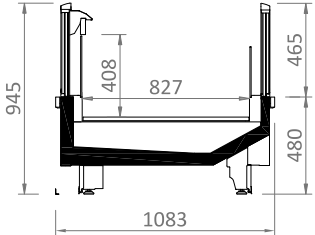
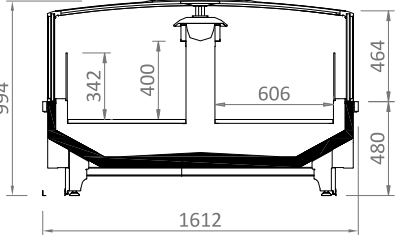
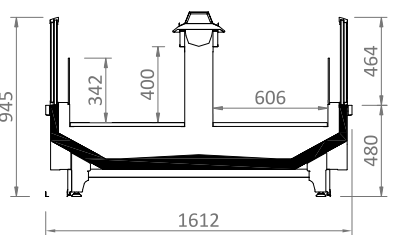
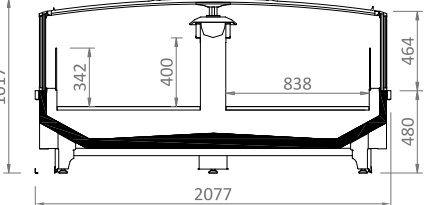
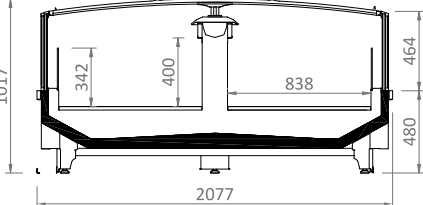
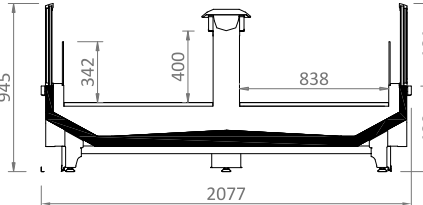
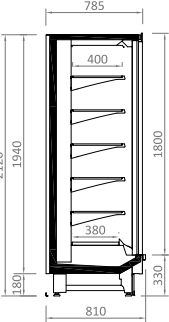
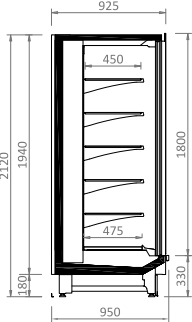
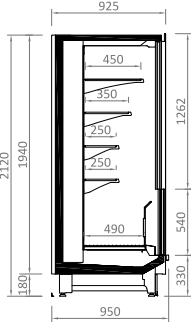
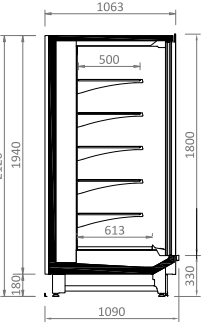
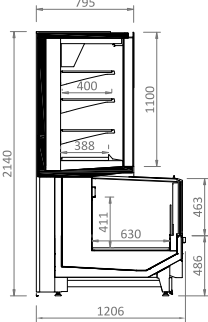
<p>VPCI</p>  <p>Technical drawing of the VPCI profile showing dimensions: total height 945, inner height 408, width 1083, and base height 480.</p>	<p>VPSIC</p>  <p>Technical drawing of the VPSIC profile showing dimensions: total height 994, inner height 400, width 1612, and base height 480.</p>	<p>VPSI</p>  <p>Technical drawing of the VPSI profile showing dimensions: total height 945, inner height 400, width 1612, and base height 480.</p>
<p>VPHIC</p>  <p>Technical drawing of the VPHIC profile showing dimensions: total height 1017, inner height 400, width 2077, and base height 480.</p>	<p>VPHICD</p>  <p>Technical drawing of the VPHICD profile showing dimensions: total height 1017, inner height 400, width 2077, and base height 480.</p>	<p>VPHID</p>  <p>Technical drawing of the VPHID profile showing dimensions: total height 945, inner height 400, width 2077, and base height 480.</p>
<p>VPCK</p>  <p>Technical drawing of the VPCK profile showing dimensions: total height 2120, inner height 1940, width 810, and base height 330.</p>	<p>VPSK</p>  <p>Technical drawing of the VPSK profile showing dimensions: total height 2120, inner height 1940, width 950, and base height 330.</p>	<p>VPSKY</p>  <p>Technical drawing of the VPSKY profile showing dimensions: total height 2120, inner height 1940, width 950, and base height 330.</p>
<p>VPHK</p>  <p>Technical drawing of the VPHK profile showing dimensions: total height 2120, inner height 1940, width 1090, and base height 330.</p>	<p>VPHY</p>  <p>Technical drawing of the VPHY profile showing dimensions: total height 2140, inner height 1100, width 1206, and base height 486.</p>	

Alguns acessórios são opcionais, consulte o representante.

Some accessories are optional, please consult the representative.

Algunos accesorios son opcionales, consulte el representante.

Tabela de especificações técnicas / Technical specifications table / Tabla de especificaciones técnicas

Modelo	Dimensões (m) / Dimensions (m) / Dimensiones (m)										Portas / Doors / Puertas					Utilização dos expositores / Use of the display units / Utilización de los exhibidores										Temperatura de operação - função / Operating temperature - function / Temperatura de operación - función												Volume interno		Área total de exposição		Tensão	Frequência	
	Modelo	1,25	1,87	2,50	3,75	E45°	E90°	I45°	I90°	Terminal	360°	2P	3P	4P	5P	Laticínios	Açougue	Confeitaria	Rotisserie	Flambéria	Hortifruti	Congelados	Peixaria	Atacado	0	4	6	-18	-20	M	F	Q	R	S	Z	Internal Volume	Total Area	Voltage	Frequency					
	Modelo														Dairy	Meat	Bakery	Rotisserie	Flambéria	Produce	Frozen food	Seafood	Wholesale													litros/m ³	m ² /m	Tensão	Frequência					
EXPOSITORES ATENDIMENTO SERVICE DISPLAY UNITS EXHIBIDORES ATENCION AL CLIENTE	VPSC	✓	✓	✓	✓										✓	✓	✓	✓	✓					✓	✓											233	1,09	220V	50/60Hz					
	VPSC-4i	✓	✓	✓	✓										✓	✓	✓	✓	✓					✓	✓										233	1,09	220V	50/60Hz						
	VP SRL	✓	✓	✓	✓										✓	✓	✓	✓	✓					✓	✓											233	1,1	220V	50/60Hz					
	VP SRL-4i	✓	✓	✓	✓										✓	✓	✓	✓	✓					✓	✓											233	1,1	220V	50/60Hz					
	VP SCB	✓	✓	✓	✓										✓	✓	✓	✓	✓					✓	✓												281	1,23	220V	50/60Hz				
	VP SRB	✓	✓	✓	✓										✓	✓	✓	✓	✓					✓	✓												281	1,23	220V	50/60Hz				
	VP HCL	✓	✓	✓	✓										✓	✓	✓	✓	✓					✓	✓												283	1,23	220V	50/60Hz				
	VP HRL	✓	✓	✓	✓										✓	✓	✓	✓	✓					✓	✓												283	1,24	220V	50/60Hz				
	VP HRLP	✓	✓	✓	✓										✓	✓	✓	✓	✓					✓	✓												283	1,24	220V	50/60Hz				
	VP XRT	✓	✓	✓	✓										✓	✓	✓	✓	✓					✓	✓													337	0,71	220V	50/60Hz			
	VP XRP	✓	✓	✓	✓										✓	✓	✓	✓	✓					✓	✓													337	0,71	220V	50/60Hz			
	VP XRM	✓	✓	✓	✓										✓	✓	✓	✓	✓					✓	✓													215	0,38	220V	50/60Hz			
	VP XRD	✓	✓	✓	✓										✓	✓	✓	✓	✓					✓	✓													381	0,98	220V	50/60Hz			
	VP XRE	✓	✓	✓	✓										✓	✓	✓	✓	✓					✓	✓													337	0,71	220V	50/60Hz			
	EXPOSITORES AUTOSERVICO SELF-SERVICE DISPLAY UNITS EXHIBIDORES AUTOSERVICIO	VP SECL	✓	✓	✓	✓										✓	✓	✓	✓	✓				✓	✓														96	0,71	220V	50/60Hz		
VP SERL		✓	✓	✓	✓										✓	✓	✓	✓	✓				✓	✓														96	0,71	220V	50/60Hz			
VP HECL		✓	✓	✓	✓										✓	✓	✓	✓	✓				✓	✓															117	0,85	220V	50/60Hz		
VP HERL		✓	✓	✓	✓										✓	✓	✓	✓	✓				✓	✓															117	0,85	220V	50/60Hz		
VP HERCL		✓	✓	✓	✓										✓	✓	✓	✓	✓				✓	✓															117	0,85	220V	50/60Hz		
VP SA3L		✓	✓	✓	✓										✓	✓	✓	✓	✓				✓	✓															249	0,77	220V	50/60Hz		
VP SA3L		✓	✓	✓	✓										✓	✓	✓	✓	✓				✓	✓															249	0,87	220V	50/60Hz		
VP HA3L		✓	✓	✓	✓										✓	✓	✓	✓	✓				✓	✓															288	1,01	220V	50/60Hz		
VP HA3LP		✓	✓	✓	✓										✓	✓	✓	✓	✓				✓	✓															288	1,01	220V	50/60Hz		
VP SPB3		✓	✓	✓	✓										✓	✓	✓	✓	✓				✓	✓															296	0,91	220V	50/60Hz		
VP SB3		✓	✓	✓	✓										✓	✓	✓	✓	✓				✓	✓															296	1,01	220V	50/60Hz		
VP HB3		✓	✓	✓	✓										✓	✓	✓	✓	✓				✓	✓															339	1,15	220V	50/60Hz		
VP SPB4		✓	✓	✓	✓										✓	✓	✓	✓	✓				✓	✓															360	1,09	220V	50/60Hz		
VP SB4		✓	✓	✓	✓										✓	✓	✓	✓	✓				✓	✓															360	1,20	220V	50/60Hz		
VP HB4		✓	✓	✓	✓										✓	✓	✓	✓	✓				✓	✓															420	1,33	220V	50/60Hz		
VP SA4L		✓	✓	✓	✓										✓	✓	✓	✓	✓				✓	✓															360	1,20	220V	50/60Hz		
VP HA4L		✓	✓	✓	✓										✓	✓	✓	✓	✓				✓	✓															360	1,20	220V	50/60Hz		
VP HA4LP		✓	✓	✓	✓										✓	✓	✓	✓	✓				✓	✓															360	1,20	220V	50/60Hz		
EXPOSITORES VERTICAIS VERTICAL DISPLAY UNITS EXHIBIDORES VERTICALES		VP SU3	✓	✓	✓	✓									✓	✓	✓	✓	✓				✓	✓																610	2,04	220V	50/60Hz	
		VP HU3	✓	✓	✓	✓									✓	✓	✓	✓	✓				✓	✓																705	2,32	220V	50/60Hz	
	VP SU4	✓	✓	✓	✓									✓	✓	✓	✓	✓				✓	✓																765	2,42	220V	50/60Hz		
	VP HU4	✓	✓	✓	✓									✓	✓	✓	✓	✓	✓				✓	✓																878	2,69	220V	50/60Hz	
	VP HCY	✓	✓	✓	✓										✓	✓	✓	✓	✓				✓	✓																249	1,05	220V	50/60Hz	
	VP HRY	✓	✓	✓	✓										✓	✓	✓	✓	✓				✓	✓															249	1,05	220V	50/60Hz		
	VP HF	0,53	1,06	2,12											✓	✓	✓	✓	✓				✓	✓															200	1,25	220V	50/60Hz		
	VP HFL-6i	✓	✓	✓	✓										✓	✓	✓	✓	✓				✓	✓															462	1,68	220V	50/60Hz		
	VP FLV	✓	✓	✓	✓										Temp. 10°C	✓	✓	✓	✓				✓	✓																250	1,45	220V	50/60Hz	
	VP M	✓	✓	✓	✓										✓	✓	✓	✓	✓				✓	✓																645	1,47	220V	50/60Hz	
	EXPOSITORES CONGELADOS FROZEN DISPLAY UNITS EXHIBIDORES CONGELADOS	VP C6	✓	✓	✓	✓									✓	✓	✓	✓	✓				✓	✓																	776	1,50	220V	50/60Hz
		VP S6	✓	✓	✓	✓									✓	✓	✓	✓	✓				✓	✓			</																	

CONTINUUM

A Continuum Refrigeração Integral é uma empresa paranaense do Grupo Eletrofrío, com sede em Curitiba/PR. Projeta e fornece soluções térmicas completas, produzindo painéis modulares com núcleo isolante em PIR, fabricados em linha contínua, totalmente automatizada e com tecnologia inovadora, garantindo controle absoluto do processo e a qualidade total dos produtos, sendo a primeira indústria a aplicar esta tecnologia no estado.



Nosso propósito é atender aos clientes de forma personalizada com investimento contínuo no desenvolvimento de tecnologias eficientes, em produtos sustentáveis, em equipamentos duráveis, com prazos e serviços comprometidos com a necessidade de cada projeto.

Continuum Refrigeração Integral is a part of the Eletrofrío Group, headquartered in Curitiba, Paraná, Brazil. It designs and provides Refrigeration Solutions for Cold Storage Warehouses and Refrigerated Retail Stores, producing modular panels with PIR insulating core. These panels are manufactured on a fully automated, continuous production line featuring innovative technology, ensuring absolute process control and total product quality. It is the first company in the state to implement this technology.

Our mission is to serve our customers in a personalized manner, with continuous investment in the development of efficient technologies, sustainable products, durable equipment, and with timelines and services committed to the needs of each project.

Continuum Refrigeração Integral es una empresa paranaense, que integra el Grupo Eletrofrío, con sede en Curitiba, Paraná, brinda soluciones térmicas integrales, produciendo paneles modulares con núcleo aislante en PIR, fabricados en línea continua, totalmente automatizados y con tecnología innovadora, garantizando control absoluto del proceso y calidad total de los productos.

Nuestro propósito es atender los clientes de forma personalizada, con inversiones continuas en desarrollo de tecnología eficiente, productos sostenibles, equipos duraderos, con plazo y servicios comprometidos con la necesidad de cada proyecto.

FAST

Há mais de 40 anos, a Fast é líder em equipamentos para lojas de autosserviço.

Com parque industrial de 155 mil m², instalada em Londrina, ao norte do estado do Paraná, sua especialidade é proporcionar aos clientes soluções na exposição de produtos, oferecendo equipamentos de excelente qualidade com alta tecnologia empregada. A Fast atende clientes dos mais variados ramos de atividade como: hiper e supermercados, atacarejos, lojas de departamentos, lojas de brinquedos, papelarias, farmácias, home centers em todo o Brasil e também no exterior.

A Fast é especialista na fabricação de gôndolas, check-outs, check-stands, rack integrado e expositores refrigerados com máquina acoplada.



For over 40 years, Fast has been a leader in self-service store equipment.

With an industrial park spans 1.67 million square feet, located in Londrina, in the northern part of Paraná, Fast specializes in providing customers with effective solutions for product display, offering high-quality equipment that incorporates advanced technology. Fast serves a wide range of sectors, including hypermarkets, supermarkets, wholesalers, department stores, toy stores, stationery stores, pharmacies, and home centers, both throughout Brazil and internationally.

Fast is an expert at manufacturing display shelves, checkouts, check-stands, storage racking systems, and refrigerated display cases plug-in.

Desde hace 40 años, Fast es especialista en equipos para tiendas de autoservicio.

Con parque industrial de 155 mil m² instalado en Londrina, Paraná, su especialidad es brindar a los clientes soluciones en exhibición de productos, ofreciendo equipos de excelente calidad y con alta tecnología utilizada. Fast atiende cliente de todos los mas variados sectores de actividad como: hipermercados, supermercados, mayoristas, tienda de departamento, tiendas de juguetes, papelerías, farmacias, home centers en todo Brasil y exterior.

Fast es especialista en fabricación de gôndolas, check outs, rack integrado y expositores autocontenidos.

Catálogos on-line.

Online Catalogs / Catálogos en línea.

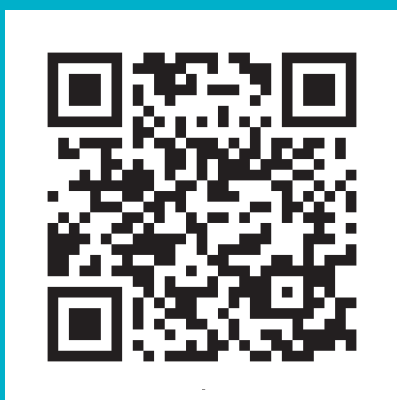

Aponte sua câmera para o QR Code e veja este e outros catálogos on-line.

Point your phone's camera at the QR Code and access other materials about our products.

Apunta tu cámara para código QR y mire ese y otros catálogo en línea.



Curitiba/PR

Rua João Chede, 1599 - CIC
Cep: 81170-220
+55 (41) 2105-6000

São Paulo/SP

Rua Dr. Renato Paes de Barros, 717
9º andar - Itaim Bibi - CEP 04530-001
+55 (11) 2105-6000

✉ marketing@eletrofrío.com.br

🌐 eletrofrío.com.br

📷 [eletrofrío_oficial](https://www.instagram.com/eletrofrío_oficial)

📘 [facebook/EletrofríoRefrigeracaoLtda](https://www.facebook.com/EletrofríoRefrigeracaoLtda)

🏢 [Eletrofrío Refrigeração Ltda](https://www.linkedin.com/company/EletrofríoRefrigeracaoLtda)